



# Thule Rapid System Kit 4024

# Thule Podium Kit 4024

# > Instructions

**FORD Focus**, 5-dr Estate, 10-

**FORD Mondeo**, 5-dr Estate, 12-14

**LINCOLN MKC**, 5-dr SUV, 14-

**This kit is only for vehicles with flush side railing.**

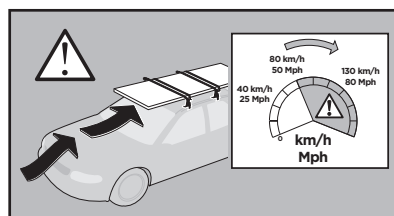
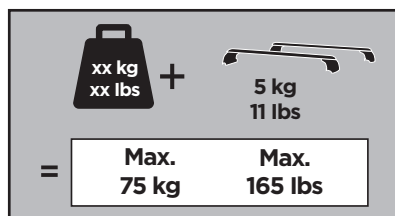
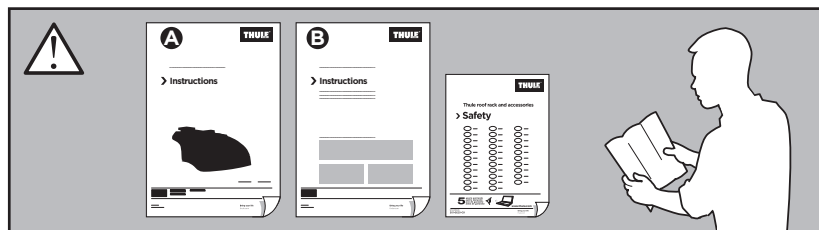

ISO 11154-E

184024

C.20150331  
509-4024-05

Bring your life

thule.com

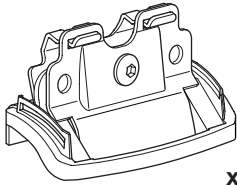

x4



52577

x1



x1

1



Thule Rapid System Foot Pack 753/7531  
Thule Podium Foot Pack 460/460R



1

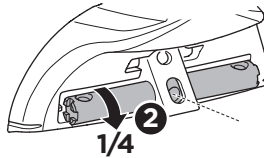

2  
1/4

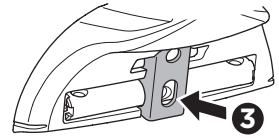

3

2

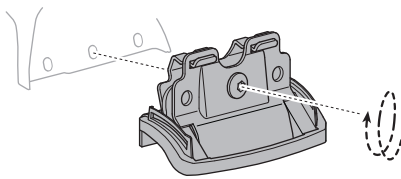

- EN Only a few turns
- DE Nur wenige Umdrehungen
- FR Quelques tours uniquement
- NL Slechts enkele slagen
- IT Solo qualche giro
- ES Sólo algunas vueltas
- PT Apenas algumas voltas
- SV Endast några varv
- DK Kun nogle få omgange
- NO Bare noen få omdreininger
- FI Vain muutama kierros

- ET Ainult mõni pööre
- LV Tikai daži apgriezieni
- LT Tik keli pasukimai
- PL Wystarczy kilka obrotów
- RU Только несколько оборотов
- UK Лише декілька обертів
- BG Само няколко завъртания
- CS Pouze několik otáček
- SK Len niekoľko otáčok
- SL Le nekaj obratov
- HR/BiH Samo nekoliko okreta
- RO Doar câteva rotiri
- HU Csak néhány fordítás
- EL Μόνο λίγες περιστροφές
- TR Yalnızca birkaç tur

بعض دورات فقط

AR

רק מספר סיבובים

HE

- ZH 仅几圈
- JA 2～3回転のみ
- KO 몇 번만 돌리면 됨
- TH เพียงสองสามรอบ

3

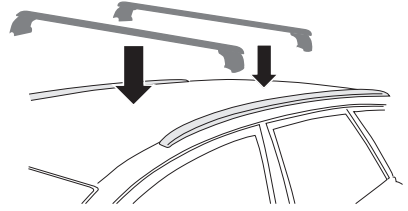

4

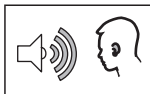
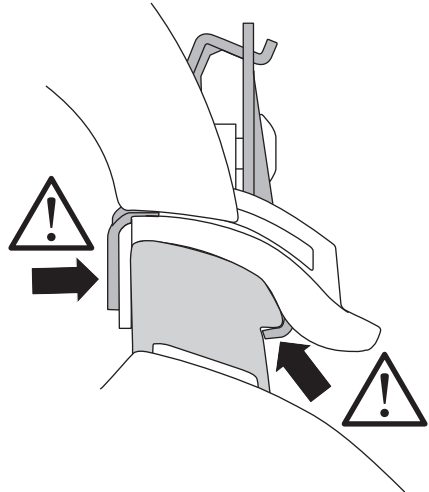
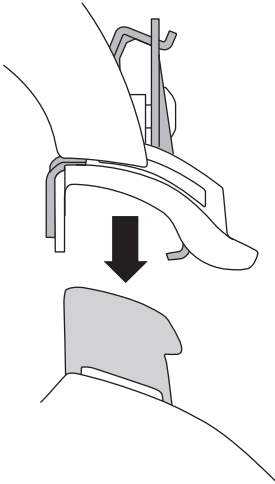

~ 700 mm

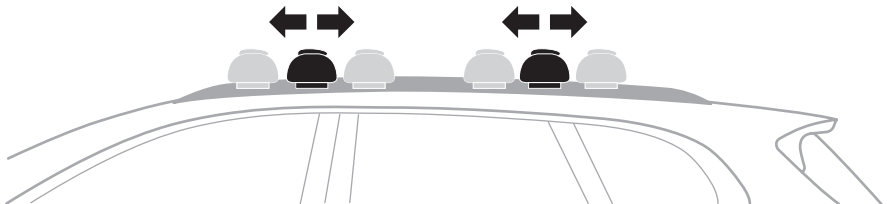
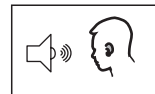

**5**

- |           |   |               |   |
|-----------|---|---------------|---|
| <b>EN</b> | Tighten alternately                                     | <b>UK</b>     | Затягти по чергово                                  |
| <b>DE</b> | Die Schrauben abwechselnd anziehen                      | <b>BG</b>     | Затегнете последователно                            |
| <b>FR</b> | Serrer alternativement chaque côté                      | <b>CS</b>     | Pokřetla багаžníka dokřečaj dokřečaj naprzemiennie. |
| <b>NL</b> | Afwisselend aan de linker- en de rechterkant aandraaien | <b>SK</b>     | Dotahujte striedavo                                 |
| <b>IT</b> | Alternare il serraggio delle viti                       | <b>SL</b>     | Privijajte izmenično                                |
| <b>ES</b> | Apretar alternativamente                                | <b>HR/BIH</b> | Naizmjenično zategnite                              |
| <b>PT</b> | Aperte alternadamente                                   | <b>RO</b>     | Strângeți alternativ                                |
| <b>SV</b> | Dra åt växelvis   | <b>HU</b>     | Egy mástól függetlenül szorítandó                   |
| <b>DK</b> | Spænd skiftevis   | <b>EL</b>     | Σφίγγετε εναλλάξ                                    |
| <b>NO</b> | Trekk til vekselvis                                     | <b>TR</b>     | Dönüşümlü sıkın                                     |
| <b>FI</b> | Kierrä vuorotellen                                      |               | إحكام الربط بالتناوب <b>AR</b>                      |
| <b>ET</b> | Pinguldage vaheldumisi                                  |               | חזק לסימון <b>HE</b>                                |
| <b>LV</b> | Pievelciet pamīšus                                      | <b>ZH</b>     | 交替拧紧  |
| <b>LT</b> | Užsukinėkite pakaitomis                                 | <b>JA</b>     | 左右交互に締めつけてください                                      |
| <b>PL</b> | Śruby dokręcaj naprzemiennie                            | <b>KO</b>     | 번갈아 조이기   |
| <b>RU</b> | Затягивайте попеременно                                 | <b>TH</b>     | ขันในแบบสลับ  |

