

# Kit 1070

ALFA ROMEO 145, 3-dr Hatchback, 95-00

ALFA ROMEO 156, 4-dr Sedan, 98-05

480R  
754

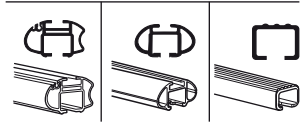
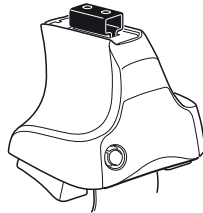

480

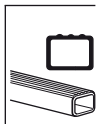
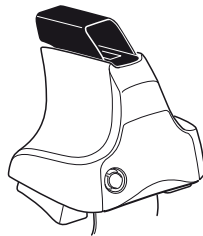

750

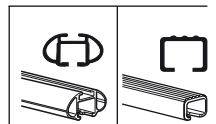
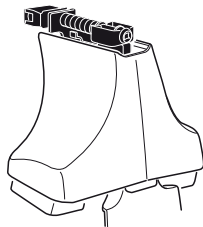



ALFA Romeo 145, 3-dr Hatchback, 95-00

Max.  
50kg/110 lbs

ALFA Romeo 156, 4-dr Sedan, 95-05

Max.  
50kg/110 lbs

80 km/h  
50 Mph  
130 km/h  
80 Mph  
40 km/h  
25 Mph  
km/h  
Mph

THULE Kit XXXX instructions

480R/754

480

750

- 2 x [Component]
- 2 x [Component]
- 2 x [Component]
- 4 x [Component]
- 2 x [Component]
- 2 x [Component]
- 2 x [Component]
- 2 x [Component]
- 2 x [Component]
- 4 x [Component]
- 4 x [Component]
- 2 x [Component]
- 2 x [Component]

- 209 x 2
- 584 x 4
- 16 x 2
- 22 x 4
- RR ↓ ↑ PR
- FL ↓ ↑ RL

**Kit**  
503-1070

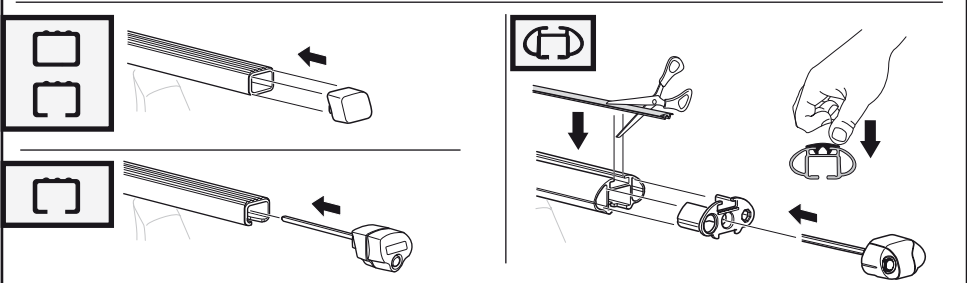
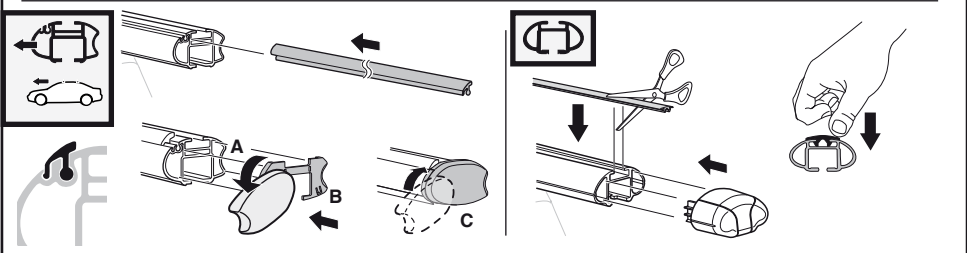
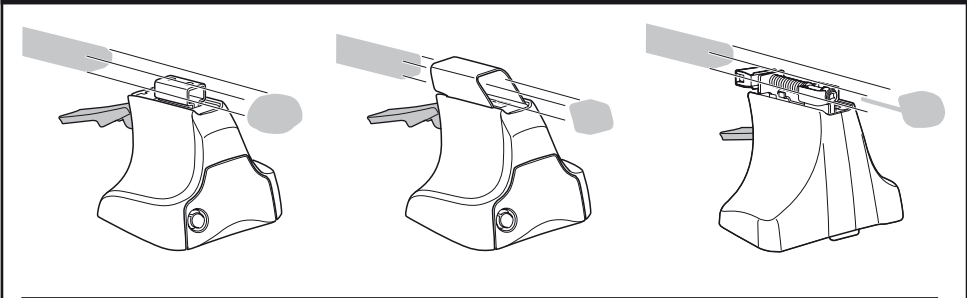
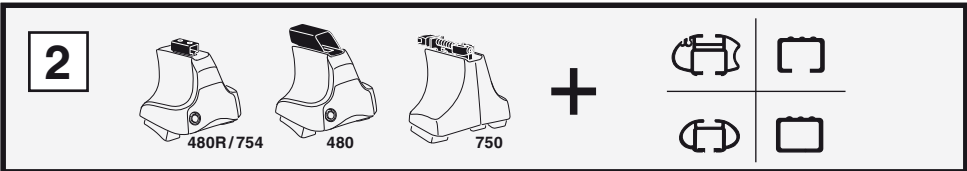
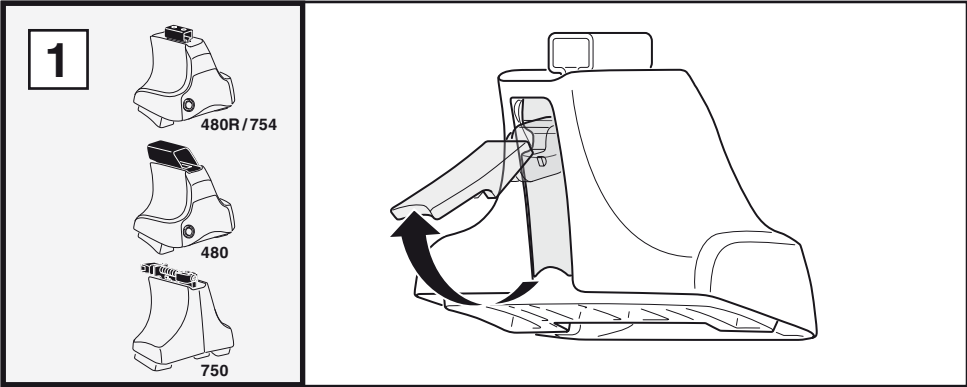

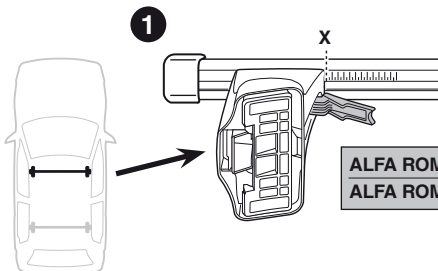
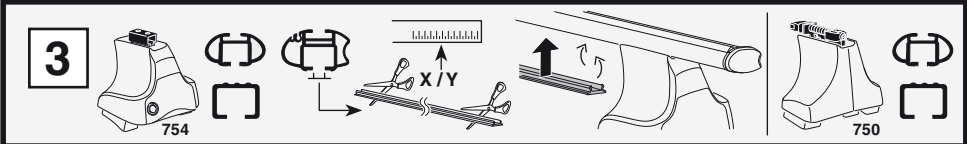

	X
ALFA ROMEO 145, 3-dr Hatchback, 95-00	30
ALFA ROMEO 156, 4-dr Sedan, 98-05	27

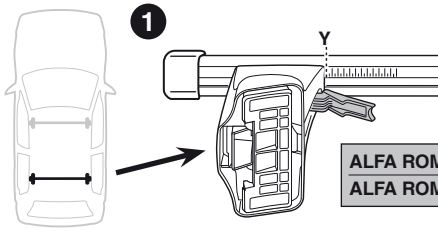

	Y
ALFA ROMEO 145, 3-dr Hatchback, 95-00	29
ALFA ROMEO 156, 4-dr Sedan, 98-05	24,5

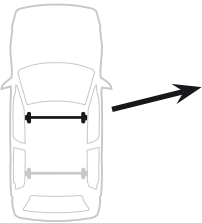
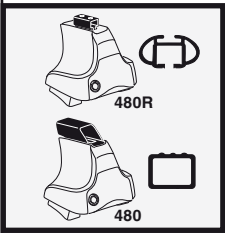

	X inch	X mm
ALFA ROMEO 145, 3-dr Hatchback, 95-00	37 1/2"	951 mm
ALFA ROMEO 156, 4-dr Sedan, 98-05	36 1/4"	921 mm

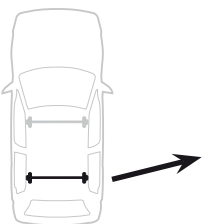

	Y inch	Y mm
ALFA ROMEO 145, 3-dr Hatchback, 95-00	37"	941 mm
ALFA ROMEO 156, 4-dr Sedan, 98-05	35 1/4"	896 mm

4

ALFA ROMEO 145, 3-dr Hatchback, 95-00

SRA

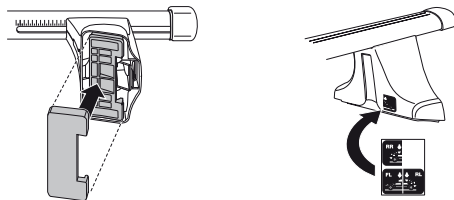
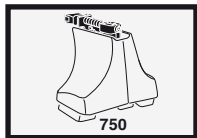
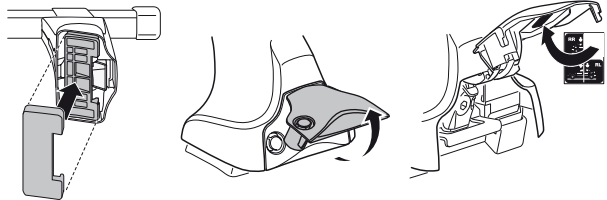
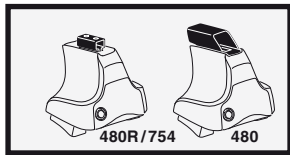
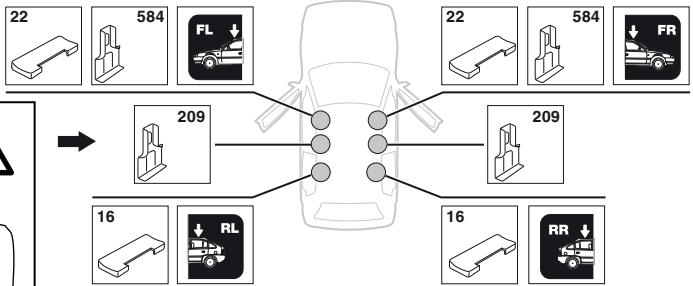
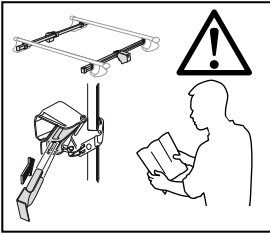

4

ALFA ROMEO 156, 4-dr Sedan, 98-05

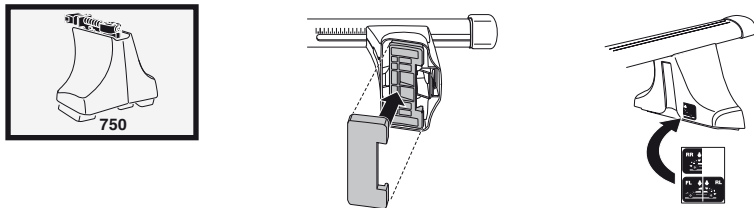
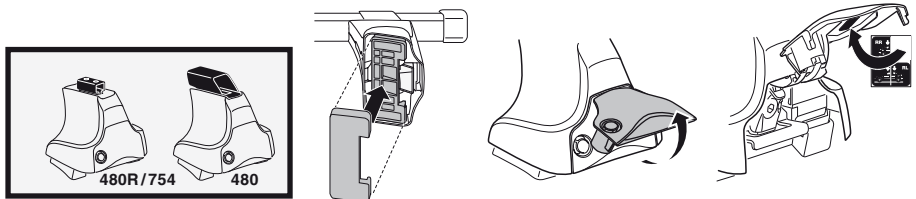
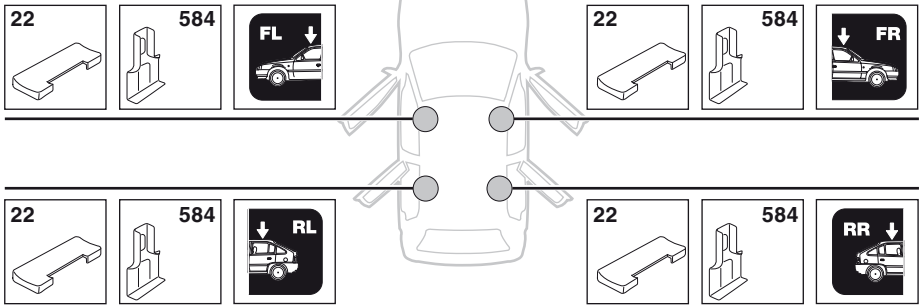

**5**

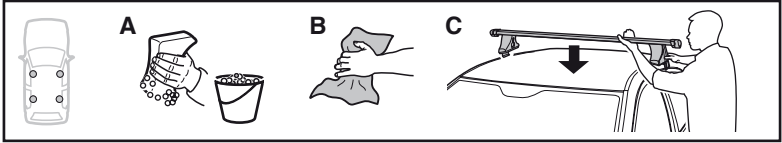

	X mm	Y mm	X inch	Y inch
<b>ALFA ROMEO 145, 3-dr Hatchback, 95-00</b>	<b>255 mm</b>	<b>700 mm</b>	<b>10"</b>	<b>27 1/2"</b>

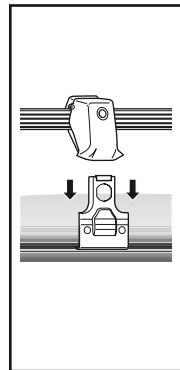
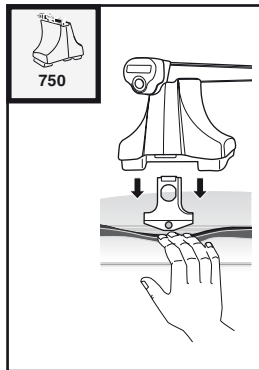
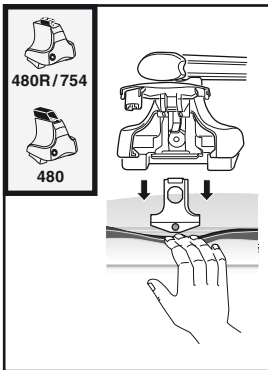
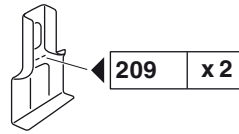
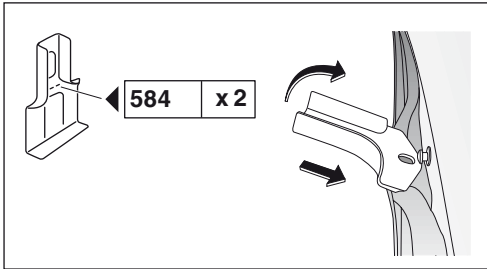
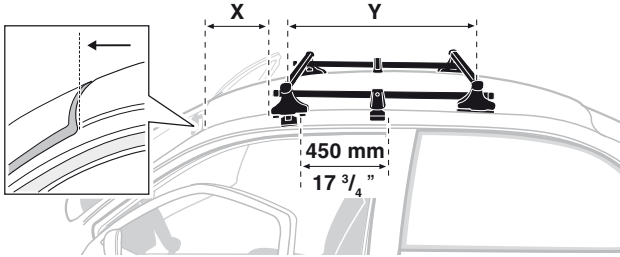



**5**

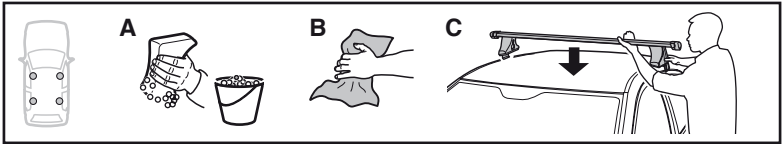

	X mm	Y mm	X inch	Y inch
<b>ALFA ROMEO 156, 4-dr Sedan, 98-05</b>	<b>205 mm</b>	<b>700 mm</b>	<b>8 1/8"</b>	<b>27 1/2"</b>

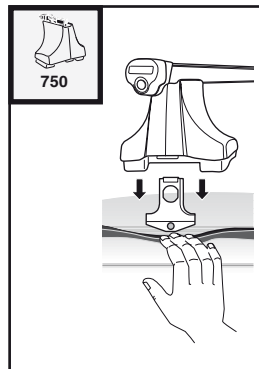
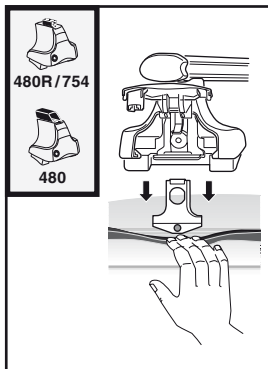
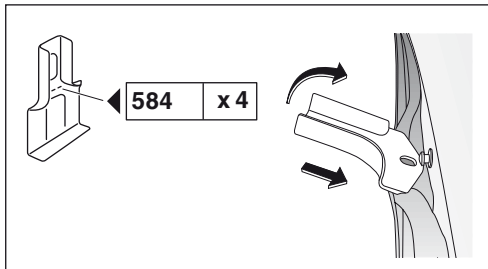
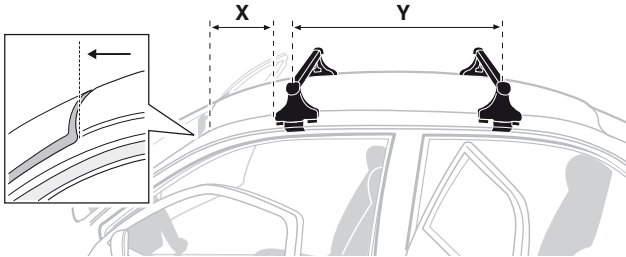

6

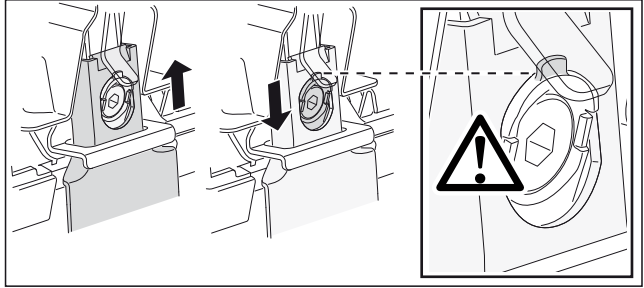
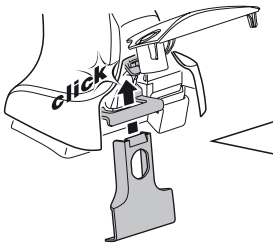

**ALFA ROMEO 145, 3-dr Hatchback, 95-00**

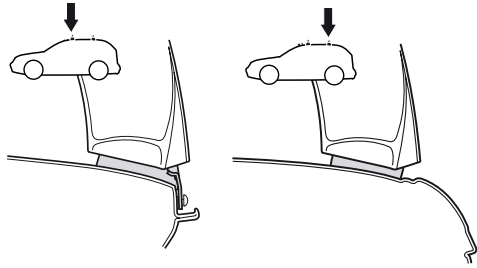

**ALFA ROMEO 156, 4-dr Sedan, 98-05**

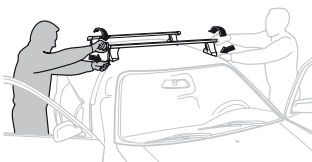
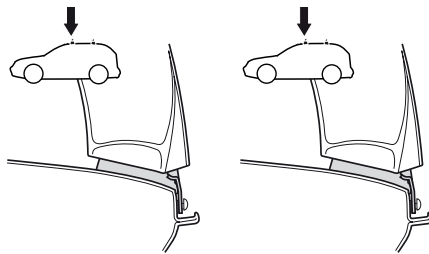

<b>GB/US</b>	Tighten alternately	<b>CZ</b>	Pokreťta bagazníka dokrećaj dokrećaj naprzemiennie.
<b>D</b>	Die Schrauben abwechselnd anziehen	<b>SK</b>	Dofahujte striedavo.
<b>F</b>	Serrer alternativement chaque côté	<b>SLO</b>	Privijajte izmjenično.
<b>NL</b>	Afwisselend aan de linker- en de rechterkant aandraaien	<b>HR</b>	Naizmjenično zategnite
<b>I</b>	Alternare il serraggio delle viti	<b>HU</b>	Egymástól függetlenül szorítandó
<b>E</b>	Apretar alternativamente	<b>GR</b>	Σφιγγετε εναλλάξ
<b>PT</b>	Aperte alternadamente	<b>TR</b>	Dönüşümlü sıkın
<b>S</b>	Dra åt växelvis	<b>中文</b>	交替拧紧
<b>FIN</b>	Kierrä vuorotellen	<b>한국어</b>	번갈아 가며 조이십시오.
<b>EST</b>	Pinguldage vaheldumisi	<b>日本語</b>	交互に締め付けてください。
<b>LAT</b>	Pielvelciot pamišus	<b>ไทย</b>	ขันในแบบสลับ
<b>LIT</b>	Užsukinėkite pakaitomis		
<b>PL</b>	Śruby dokrećaj naprzemiennie		
<b>RU</b>	Затягивайте попеременно		

7



480R/754



480

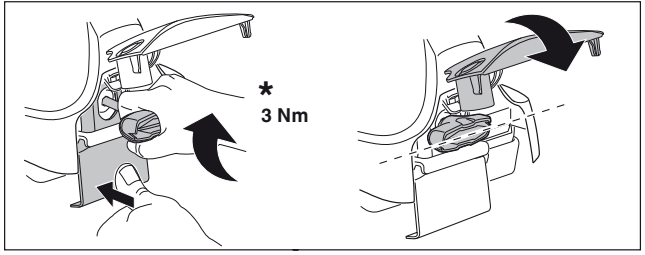
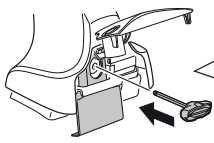

\*  
3 Nm

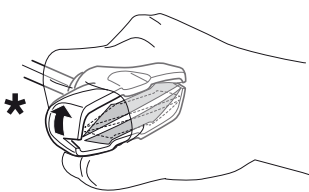

\*

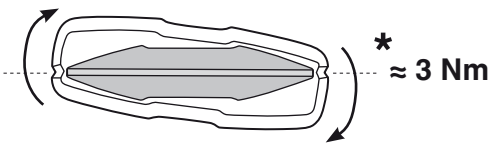

\*  
≈ 3 Nm

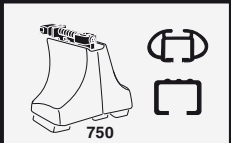
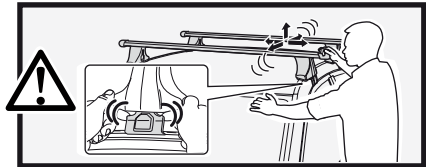

750

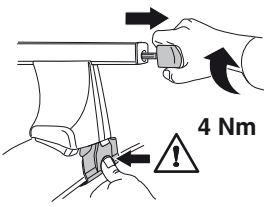

4 Nm

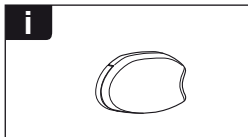
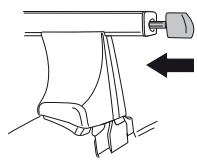

i



1

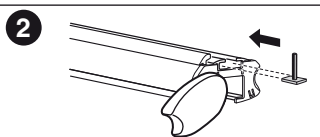

2

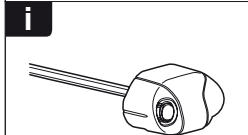

i

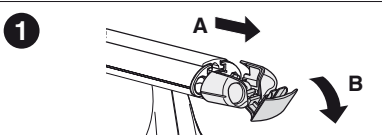

1

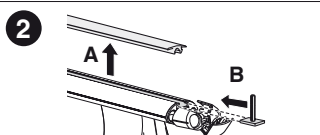

2

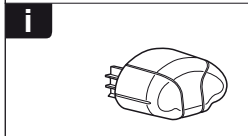

i

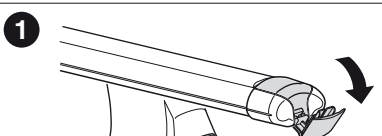

1

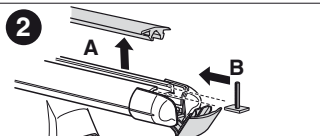

2

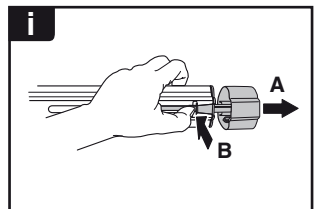
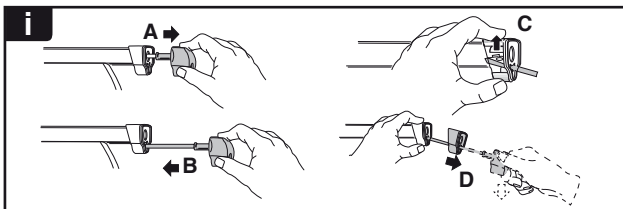
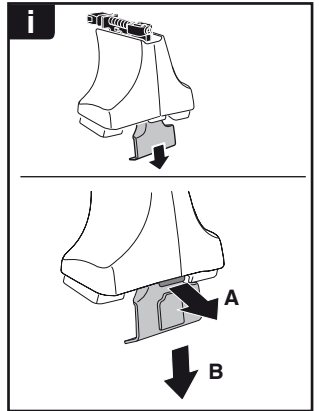
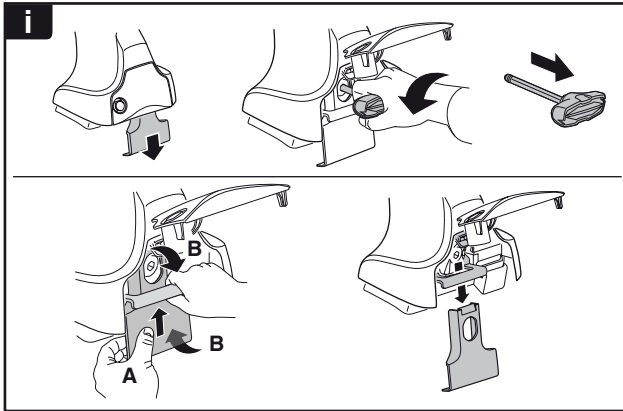
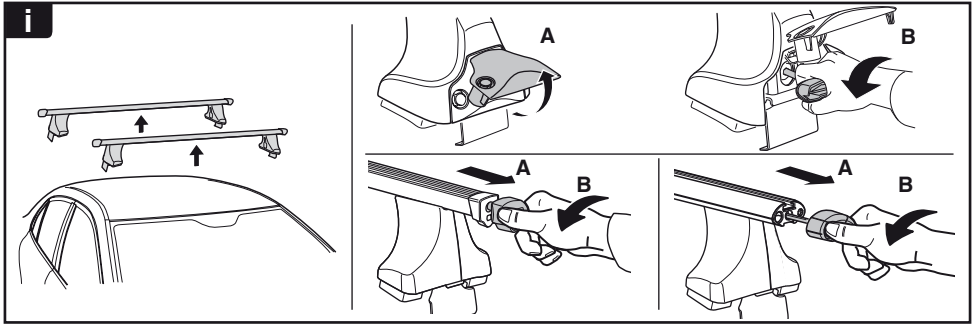

**THULE**  
SWEDEN  
**ONE  
KEY  
SYSTEM**

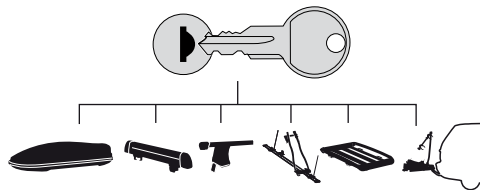

- 544 (x4)
- 596 (x6)
- 588 (x8)
- NA 510 (x10)
- EUR 452 (x12)
- ASIA

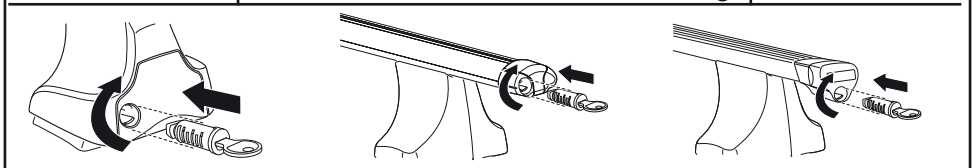

WW ▶ Thule Sweden AB, Box 69, 330 33 Hillerstorp, SWEDEN  
NA ▶ Thule Inc., 42 Silvermine Road, Seymour, Connecticut 06483, USA

info@thule.com  
customer.service@thule.com

www.thule.com